

34MM 385X505+30CM SDDDP01 + EDC01L (ART 6012)

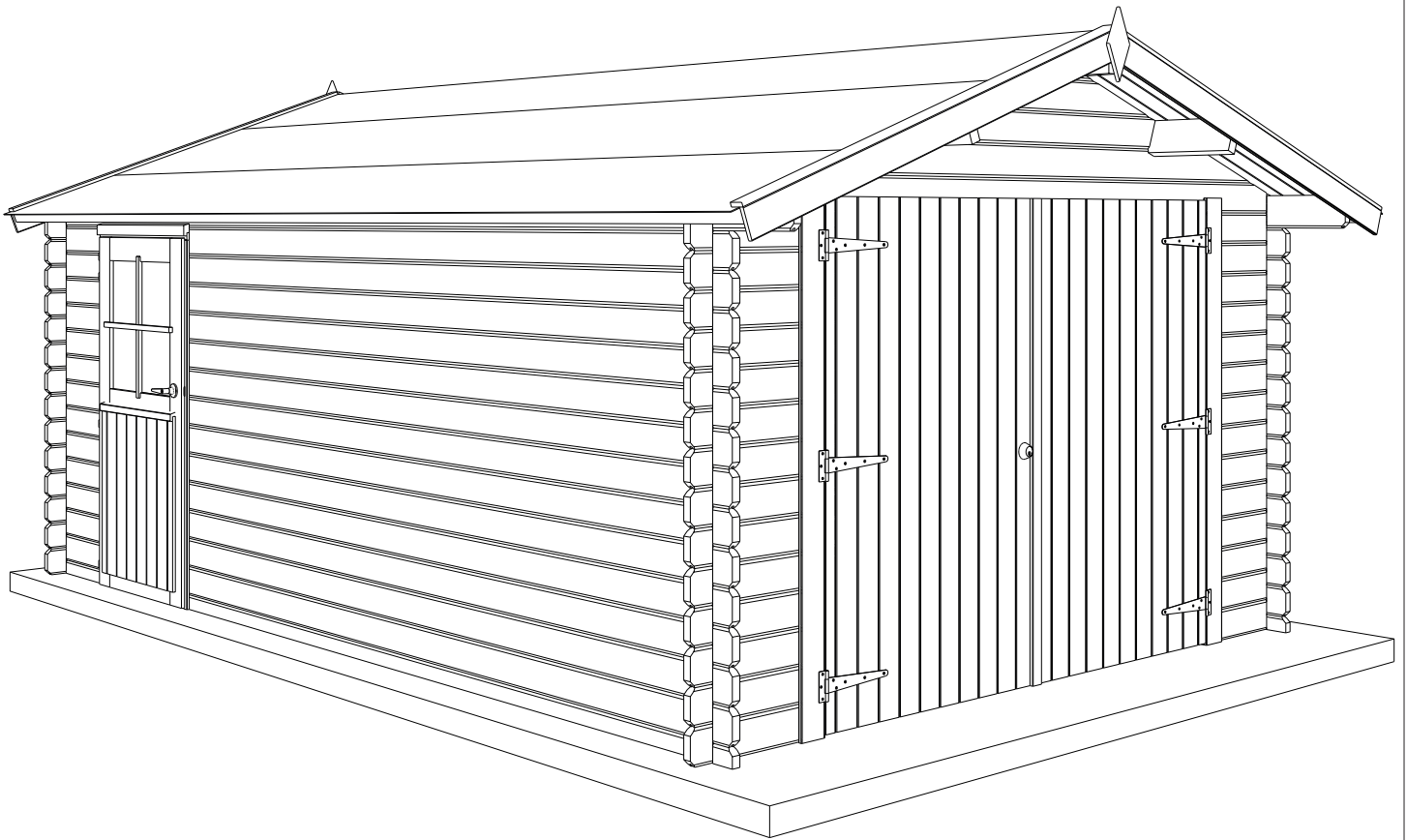

GARDENAS

TIMBER GARDEN CONSTRUCTIONS

GEDETAILLEERDE ONDERDELENLIJST

-

LISTE D'INVENTAIRE DETAILLEE

Onderdelenlijst Liste d'inventaire

**! Typ
Diamond**

34mm 385x505 + 30 SDDDP01 + EDC01L

6012

Artikel nr Afmeting / Dimension # Functie/Fonction
Nr Article A B C

Wandelementen / Éléments des parois

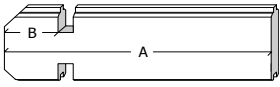

F1/0727/0100	727	100	(-)	<u>28</u>	naast poort voorgevel / côté porte façade
F1/0577/0100	577	100	(-)	<u>13</u>	naast deur zijgevel / côté porte paroi latéral
F1/3573/0100	3573	100	(-)	<u>13</u>	naast deur zijgevel / côté porte paroi latéral

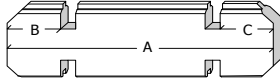

F3/3850/0100/100	3850	100	100	<u>14</u>	achtergevel / paroi arrière
F3/5050/0100/100	5050	100	100	<u>13</u>	zijgevel / paroi latérale

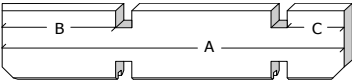

F5/5350/0400/100	5350	400	100	<u>2</u>	oversteek zijgevel / traverse paroi latérale
------------------	------	-----	-----	----------	--

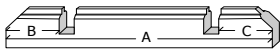

F7/5050/0100/100	5050	100	100	<u>2</u>	basis zijgevel / base paroi latérale
------------------	------	-----	-----	----------	--------------------------------------

Dakelementen / Éléments du toit



FK/S/3850/3/2	3850	(-)	(-)	<u>2</u>	puntgevel te assembleren / pignon à assembler
---------------	------	-----	-----	----------	---

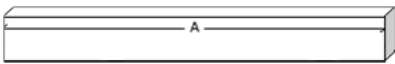

P2/5350/0400/100	5350	400	100	<u>3</u>	dakbalk / panne de toit
------------------	------	-----	-----	----------	-------------------------



DP/2080	2080	(-)	(-)	<u>94</u>	dakplanchet / planchette du toit
---------	------	-----	-----	-----------	----------------------------------

Afwerkingselementen / Éléments de finition



SRD/0930	930	(-)	(-)	<u>2</u>	sierlat boven deuren / latte de finition cadre de porte
----------	-----	-----	-----	----------	---



FSL/2100	2100	(-)	(-)	<u>4</u>	frontale sierlat / latte de finition frontale
----------	------	-----	-----	----------	---



SSL/2100	2100	(-)	(-)	<u>4</u>	stormsierlat op het dak / Latte de finition sur le toit
SSL/1920	1920	(-)	(-)	<u>1</u>	makelaar deur / Latte de cache porte



S	(-)	(-)	(-)	<u>2</u>	schildje / ecusson
---	-----	-----	-----	----------	--------------------



ZSL/5350	5350	(-)	(-)	<u>2</u>	Zijsierlat tegen dakplanchet / finition latérale contre planchette du toit (kan in 2 delen zijn / peut être en 2 parties)
----------	------	-----	-----	----------	--

Dubbele Poort + 2 steilen / Porte Double + 2 él. chassis

D/DDP01	<u>1</u>
---------	----------

Enkele Deur + Deurkader / Porte Simple + chassis

D/EDC01L-G	<u>1</u>
------------	----------

Beslag / Quincaillerie

BESLAG/66	<u>1</u>
-----------	----------

Roofing Rol /rouleau 11,85 m

snijdt in 2x5,75 m / Coupez en 2x5,75 m

3183R1185/1	11850	<u>2</u>
-------------	-------	----------

Roofing Rol /rouleau 6 m

snijdt in 5,75 m / Coupez en 5,75 m

3183R0600/1	6000	<u>1</u>
-------------	------	----------

34MM 385X505+30CM SDDDP01 + EDC01L (ART 6012)

VOORZIJDE - FACADE

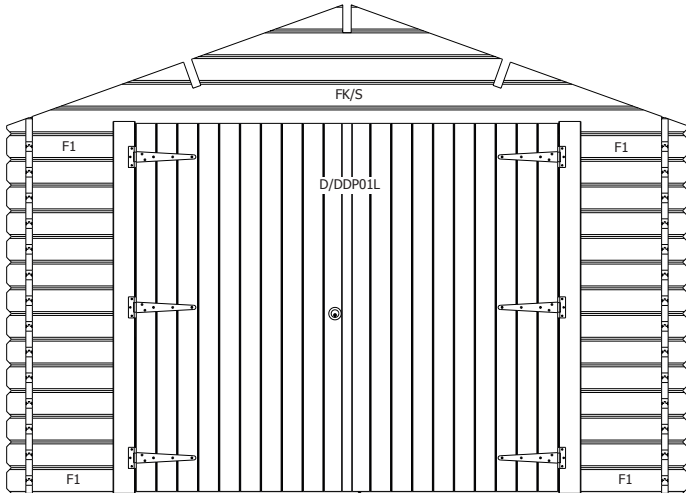

RUGZIJDE - PAROI ARRIERE

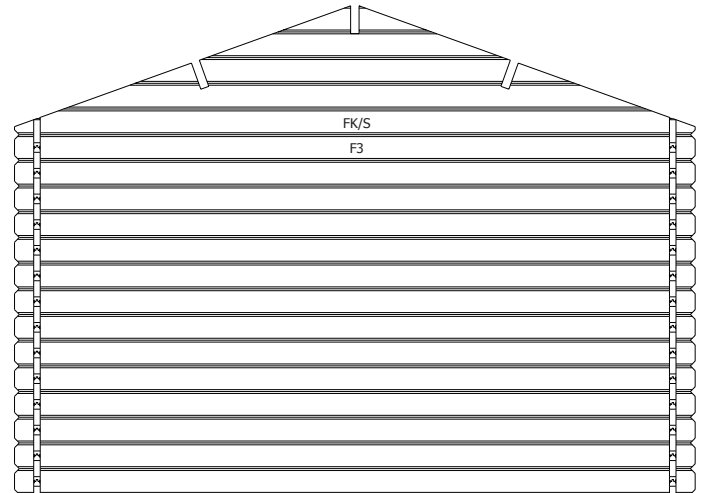

ZIJWAND - PAROI LATERALE

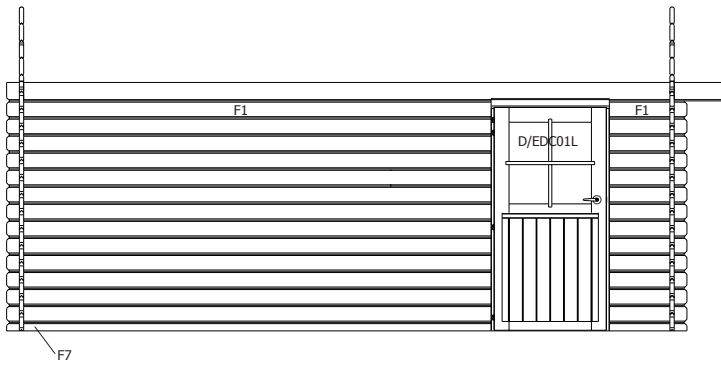

ZIJWAND - PAROI LATERALE

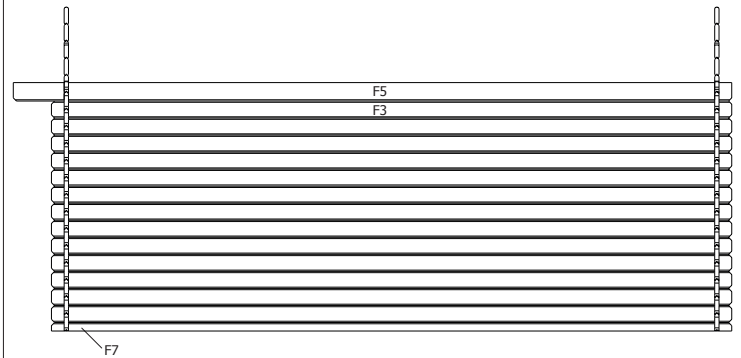

DAK - TOITURE

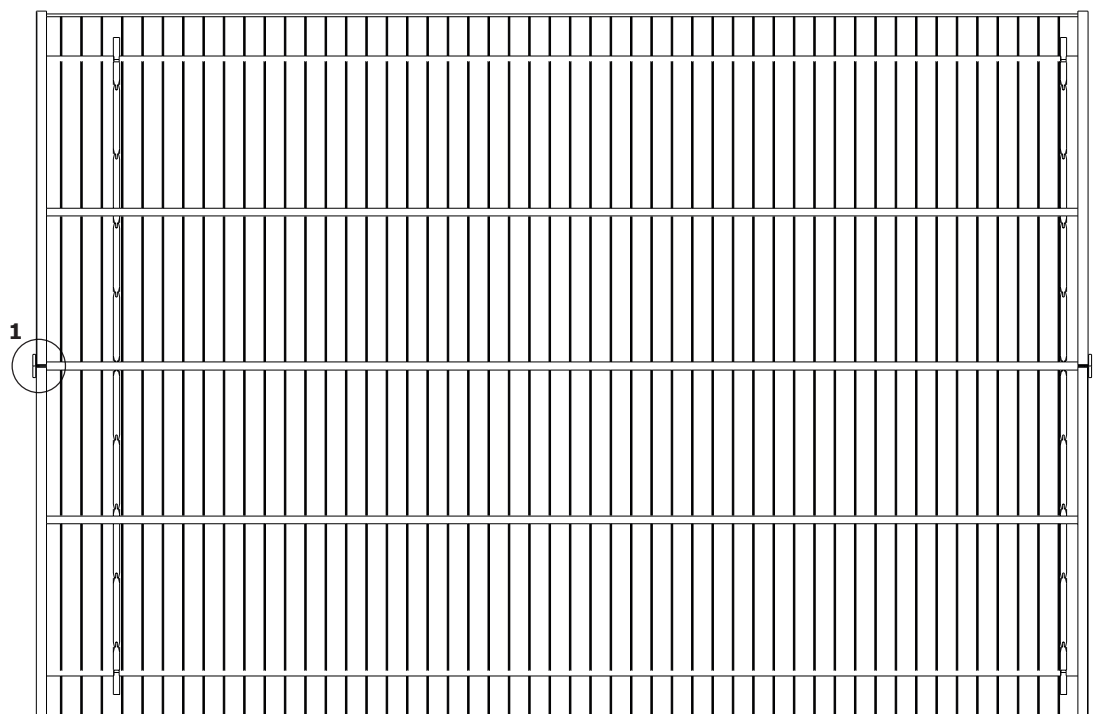
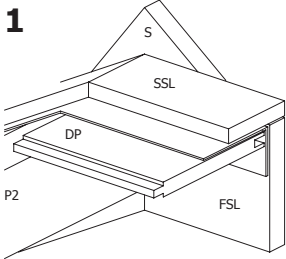

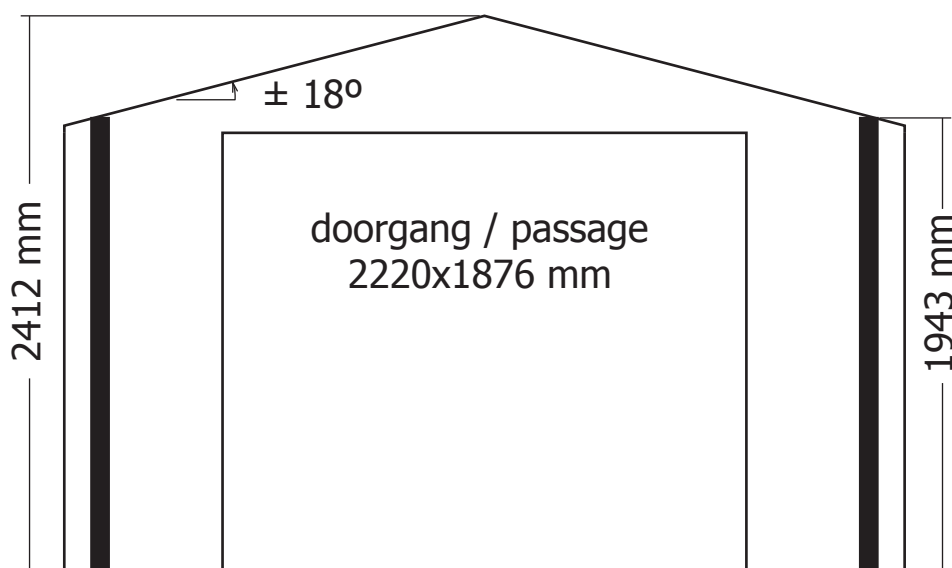
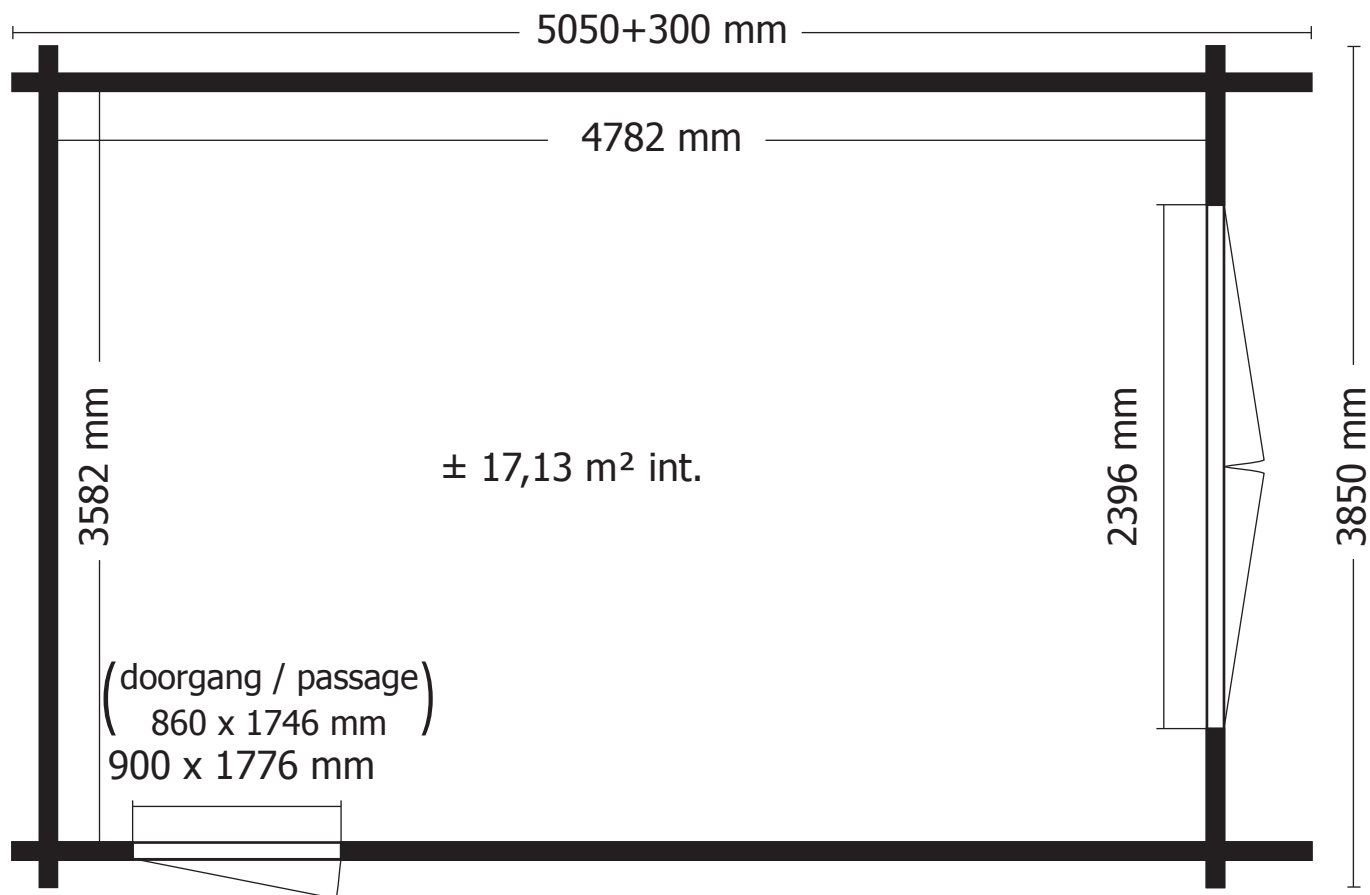

OPGELET : Behandel **ELK** onderdeel grondig aan alle zijden met een degelijk product dat beschermt tegen zon, weer en wind en tegen insecten en schimmels, **VOOR** de montage.

ATTENTION : Traitez à fond **CHAQUE** élément avec un produit protégeant contre les intempéries, les insectes et les moisissures intérieur et extérieur, **AVANT** le montage .