

44MM 400x295 CM PDEXT (ART4600AB4030AC/ISO)

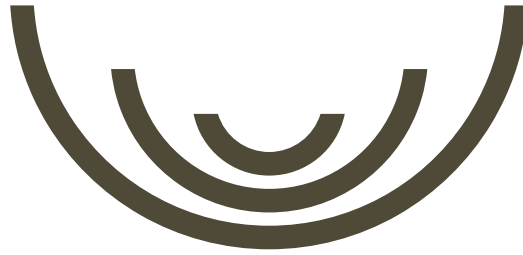

WOODLANDS

QUALITY CABINS

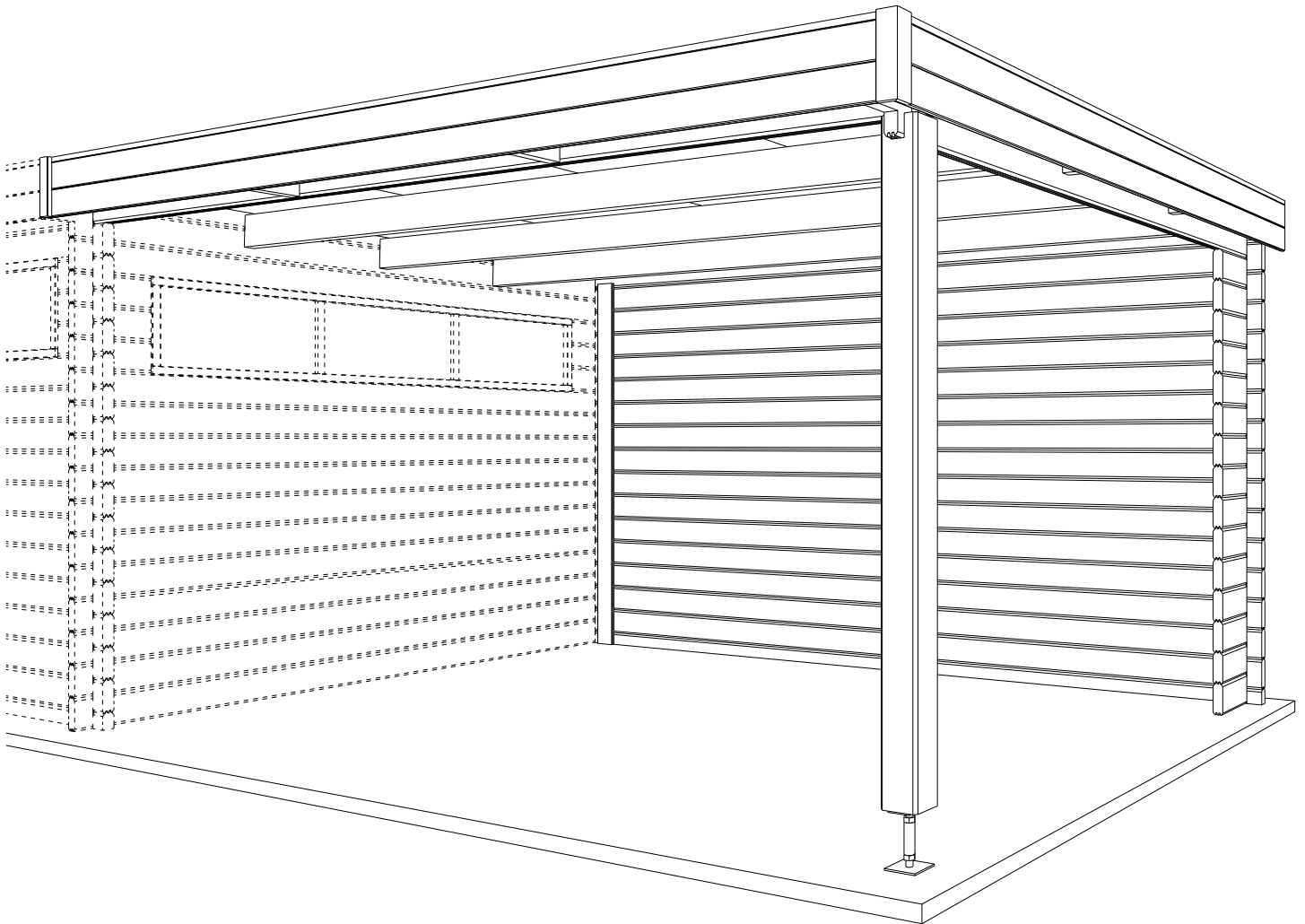

GEDETAILLEERDE ONDERDELENLIJST

-

LISTE D'INVENTAIRE DETAILLEE

Download uw montage instructies op www.gardenas.be

Téléchargez vos instructions de montage sur www.gardenas.be

Onderdelenlijst Liste d'inventaire

Typ **44mm 400x295 cm EXTPD**

4600AB4030

Artikel nr / Nr Article Afmeting / Dimension # Functie / Fonction

Wandelementen / Éléments des parois

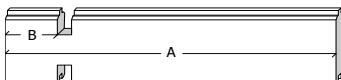

Z1/0425/0070	425	70	(-)	15	zijgevel extensie / paroi latéral extension
Z1/3955/0070	3955	70	(-)	15	achtergevel extensie / paroi arrière extension

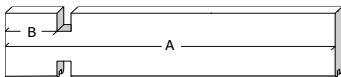

Z5/4070/0070	4070	70	(-)	1	bovenste plank voorgevel extensie / planche supérieure façade extension
--------------	------	----	-----	----------	---

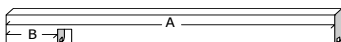

Z0/4070/0070	4070	70	(-)	1	bovenste plank achtergevel ext / planche supérieure paroi arrière ext
--------------	------	----	-----	----------	---

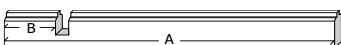

Z7/3955/0070	3955	70	(-)	1	basis achtergevel extensie / base paroi arrière extension
--------------	------	----	-----	----------	---

Dakelementen / Éléments du toit



ZK/P2/3075	3075	195	70	1	helling / pente
------------	------	-----	----	----------	-----------------

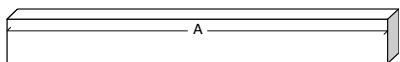

599937	1909	(-)	(-)	1	paal / poteau
HDB/SET9				1	zak balkjes + sierlatjes / sachet poutres + lattes de finitions
P2/3956	3956	145	44	3	dakbalk / poutre du toit



300035	290	120	120	1	U-anker / U-socle
--------	-----	-----	-----	----------	-------------------



PPD1AC/3175/1000	3175	1000	(-)	4	profielplaten / panneaux profilés
------------------	------	------	-----	----------	-----------------------------------

Afwerkingselementen / Éléments de finition

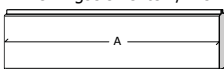

FSLMA/4080/115	4080	115	(-)	1	frontale sierlat tand / latte de finition frontale languette
FSLMB/4080/108	4080	108	(-)	1	frontale sierlat groef / latte de finition frontale rainure



te zagen op lengte 4000 mm / à scier sur longueur 4000 mm

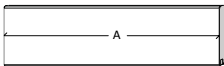

S/045/045/2010	2010	45	45	1	balkje verbinding achterwand / poutrelle connection par. arrière
SSL45/4200	4200	(-)	(-)	1	stormsierlat op het dak (voorkant) / latte de finition sur le toit (façade)

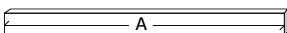

FSL/2100	2100	(-)	(-)	1	sierlat verbinding achterwand / latte de finition connection par. arrière
----------	------	-----	-----	----------	---

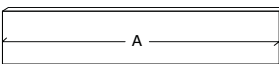

599906	2100	(-)	(-)	1	sierlat verbinding achterwand / latte de finition connection par. arrière
--------	------	-----	-----	----------	---

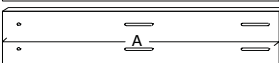

B/4600AB				1	zak beslag / sachet quincaillerie
----------	--	--	--	----------	-----------------------------------

44MM 400X295 CM EXTPD (ART 4600AB4030AC/ISO)

ZIJAANZICHT - VUE LATERALE

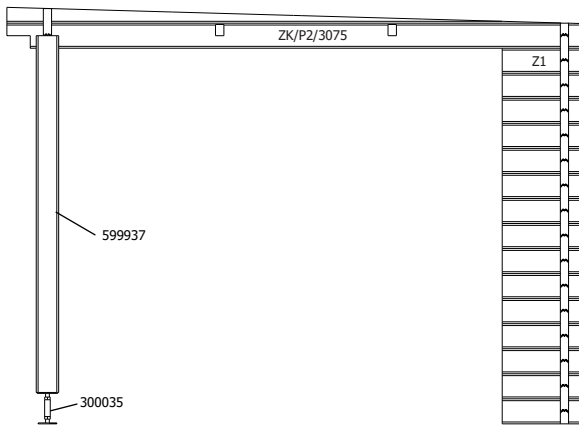

VOORZIJDE - FACADE

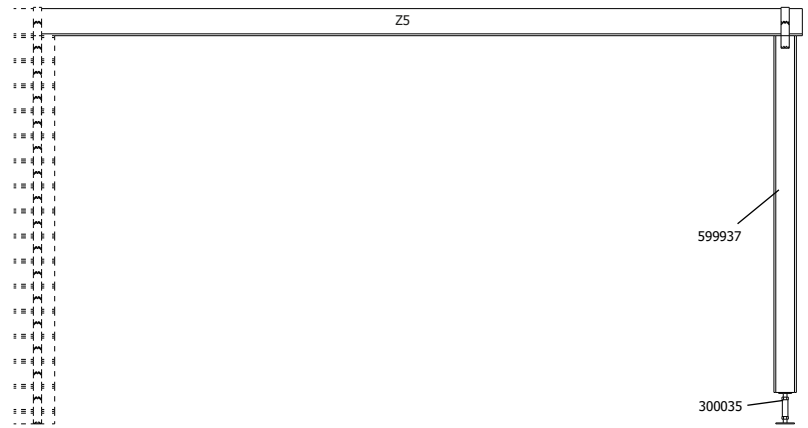

ACHTERZIJDE - VUE ARRIERE

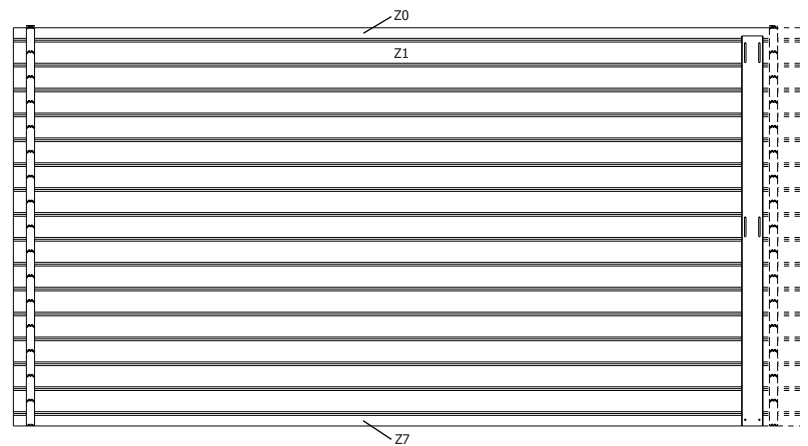

DAK - TOITURE

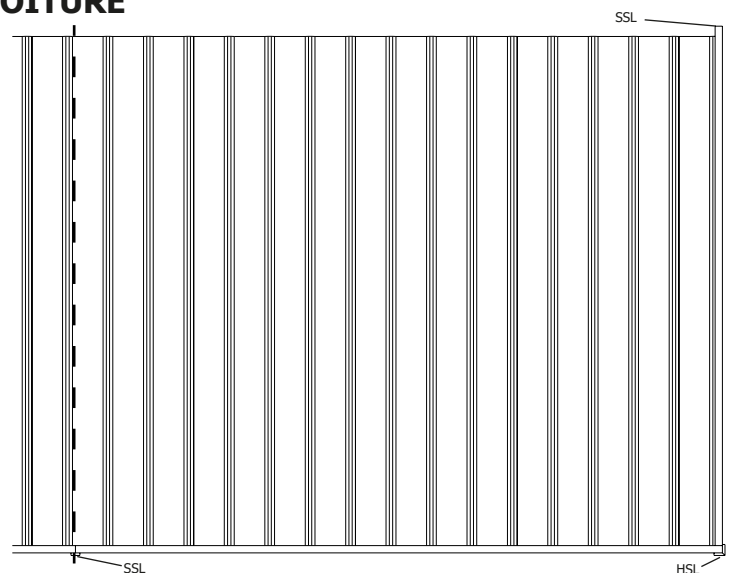
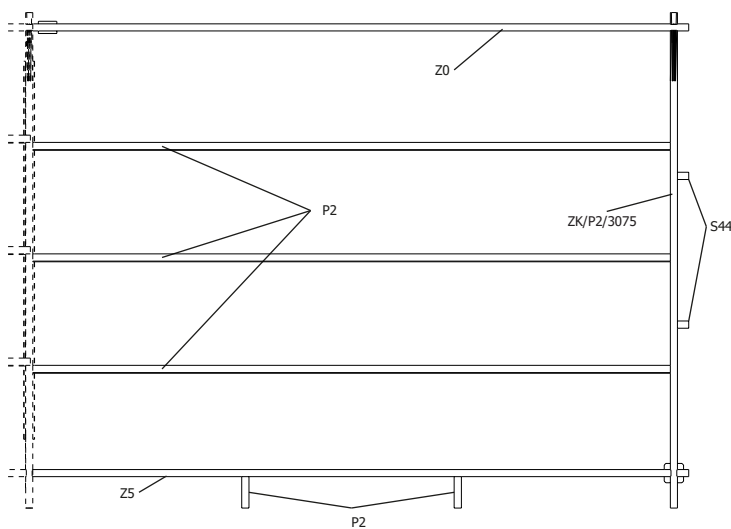

plaatsing van de staalplaten (vooraanzicht) - pose du toit en tôle (vue de face)

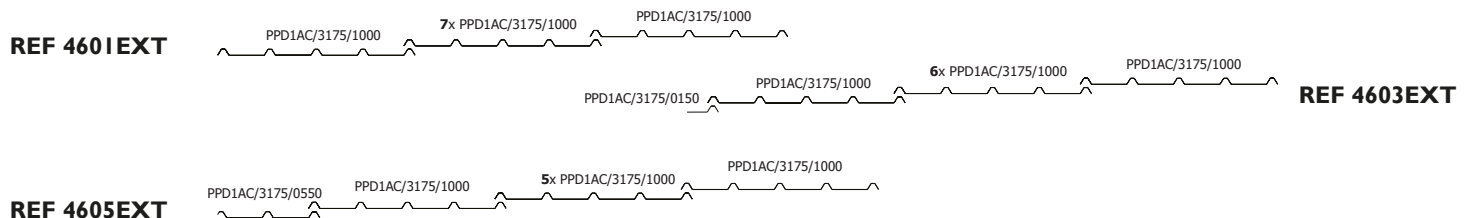

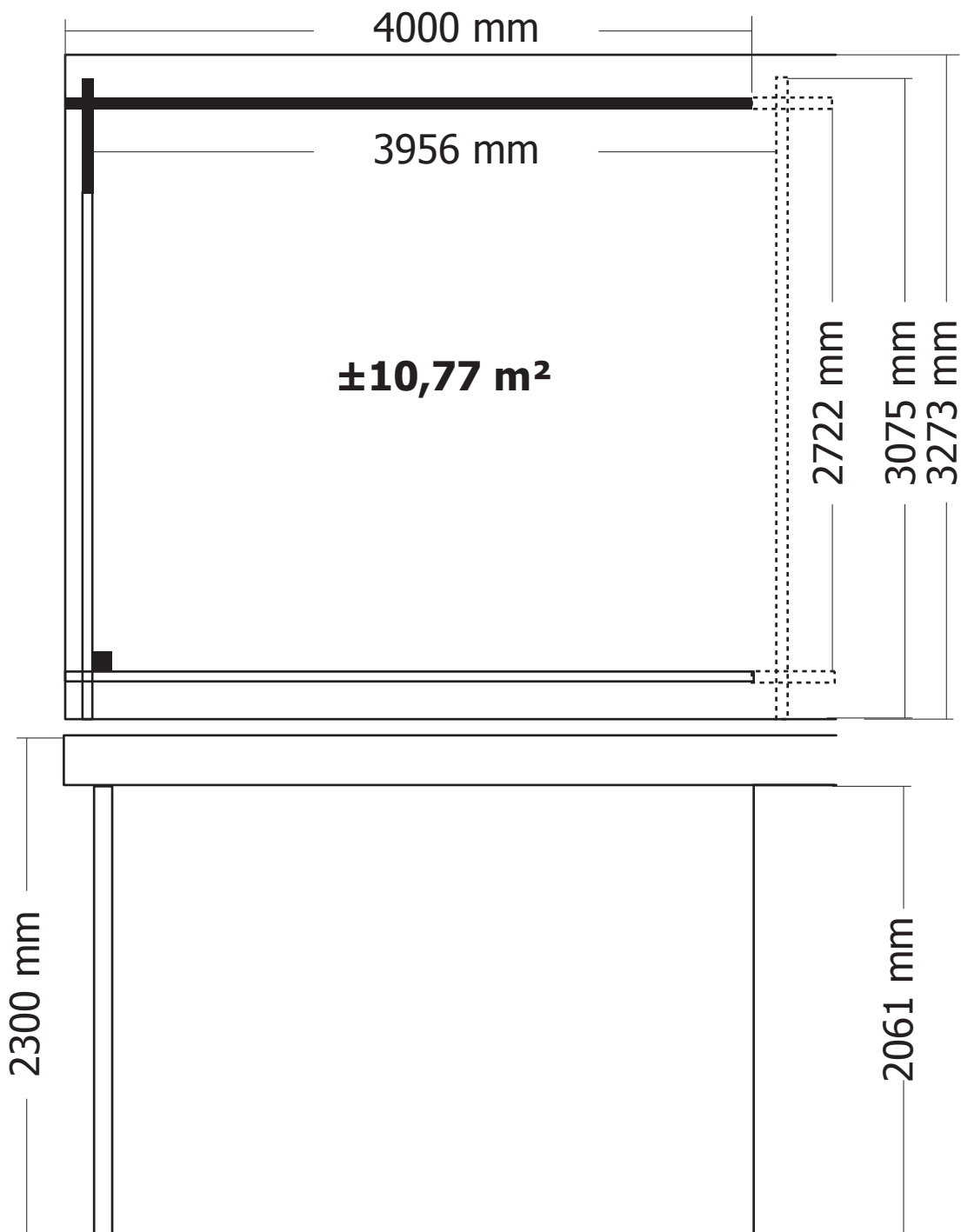

OPGELET : Behandel **ELK** onderdeel grondig aan alle zijden met een degelijk product dat beschermt tegen zon, weer en wind en tegen insecten en schimmels, **VOOR** de montage.

ATTENTION : Traitez à fond **CHAQUE** élément avec un produit protégeant contre les intempéries, les insectes et les moisissures intérieur et extérieur, **AVANT** le montage .

B/4600AB

Rondel - Rondelle (M8)
(Ref = 330001)



aantal / nombre

10

Houtdraadbout - Boulon (8x40)
(Ref = 340002)



10

Schroeven - Vis

25mm
(Ref = 310018)

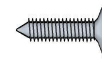

10

35mm
(Ref = 310007)



20

50mm
(Ref = 310013)



16

70mm
(Ref = 310009)



8

100mm
(Ref = 310005)



28

Schroef + kapje - Vis + capuchon (100mm)
(Ref = 310005 & 399007)



65

HDB/SET9

Voor artikel / Pour article:

4600AB4030

4600AB4040

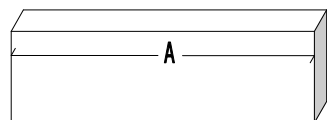

<u>ARTIKEL NR</u>	<u>AANTAL</u>	<u>FUNCTIE</u>
<u>NR ARTICLE</u>	<u>NOMBRE</u>	<u>FONCTION</u>
P2/0195	2	hulpdakbalk / poutre de toit d'aide

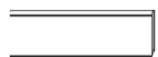

SSL/0230	2	sierlat / latte de finition
----------	---	-----------------------------